

# Installation Type:

**1**

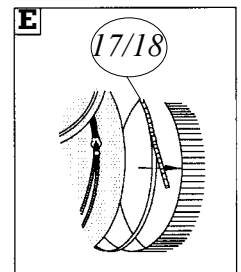

*min/lin.m*

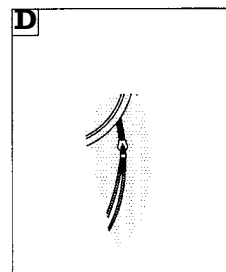
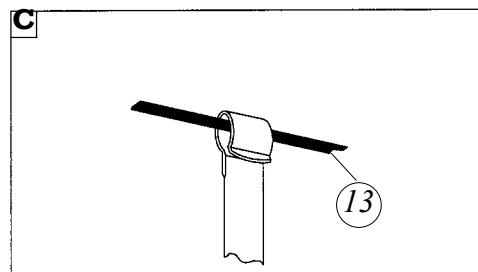
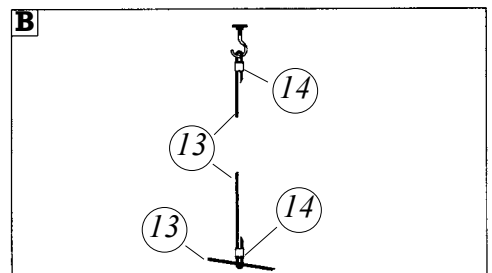
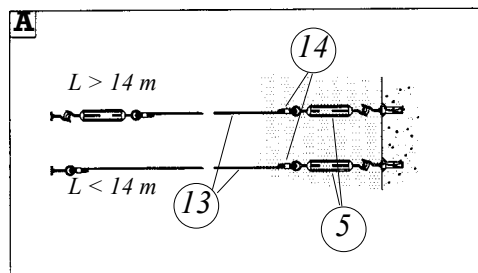
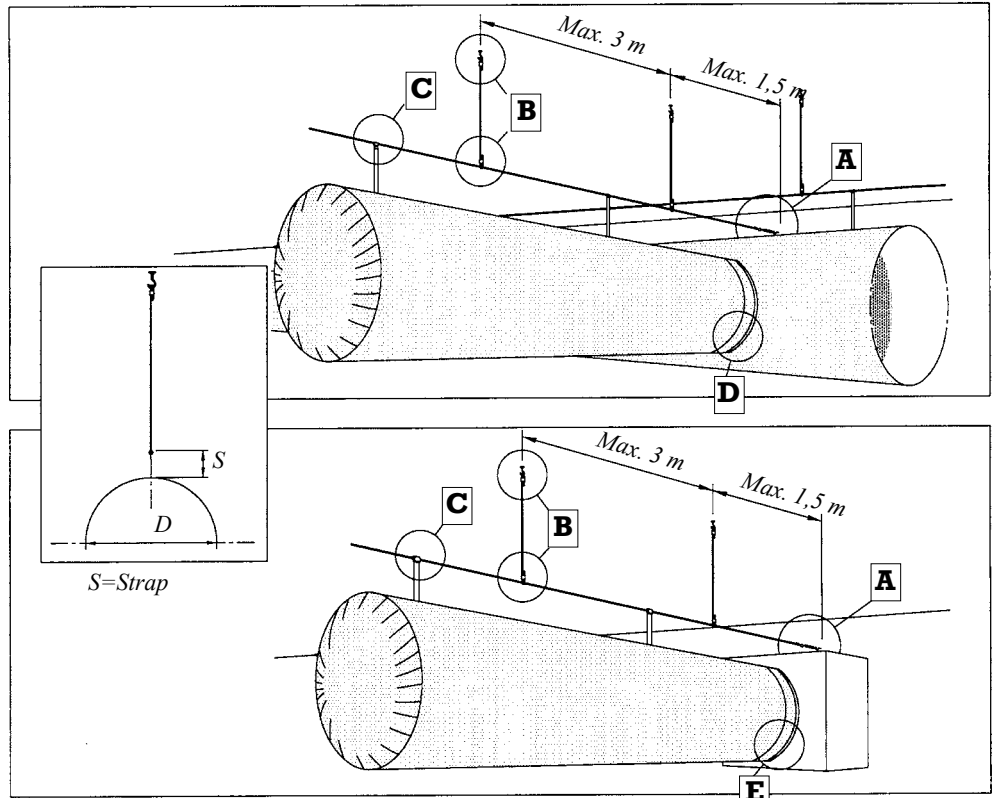

## Standard



Stretcher

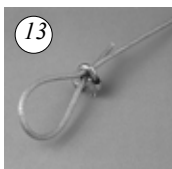

Wire



Wire lock



Fixing strap  
No. 17 - max. dia.500 mm



Fixing strap  
No. 18 - dia > 500 mm

**FabricAir**